

PKC3000

PTZ CAMERA  
JOYSTICK CONTROLLER

**AVMATRIX**<sup>®</sup>



**PKC3000**

**PTZ CAMERA JOYSTICK CONTROLLER**

## USING THE UNIT SAFELY

Before using this unit, please read below warning and precautions which provide important information concerning the proper operation of the unit. Besides, to assure that you have gained a good grasp of every feature of your new unit, read below manual. This manual should be saved and kept on hand for further convenient reference.



### Warning And Cautions

- ※ To avoid falling or damage, please do not place this unit on an unstable cart, stand, or table.
- ※ Operate unit only on the specified supply voltage.
- ※ Disconnect power cord by connector only. Do not pull on cable portion.
- ※ Do not place or drop heavy or sharp-edged objects on power cord. A damaged cord can cause fire or electrical shock hazards. Regularly check power cord for excessive wear or damage to avoid possible fire / electrical hazards.
- ※ Do not operate unit in hazardous or potentially explosive atmospheres. Doing so could result in fire, explosion, or other dangerous results.
- ※ Do not use this unit in or near water.
- ※ Do not allow liquids, metal pieces, or other foreign materials to enter the unit.
- ※ Handle with care to avoid shocks in transit. Shocks may cause malfunction. When you need to transport the unit, use the original packing materials or alternate adequate packing.
- ※ Do not remove covers, panels, casing, or access circuitry with power applied to the unit! Turn power off and disconnect power cord prior to removal. Internal servicing / adjustment of unit should only be performed by qualified personnel.
- ※ Turn off the unit if an abnormality or malfunction occurs. Disconnect everything before moving the unit.

Note: due to constant effort to improve products and product features, specifications may change without notice.

## CONTENT

1. Brief Introduction .....	1
1.1 Overview .....	1
1.2 Main Features .....	1
2. Interfaces .....	2
2.1 Interfaces .....	2
2.2 Interface definition .....	2
2.3 Specification .....	3
3. Control Panel .....	5
3.1 Description .....	5
3.2 Keyboard Button .....	6
4. Menu Settings .....	8
4.1 STATUS .....	8
4.2 SETUP .....	9
4.2.1 IP Config .....	9
4.2.2 LED setting .....	10
4.2.3 Assigned key .....	10
4.2.4 Advanced .....	11
4.2.5 Version .....	13
4.2.6 Reset .....	13
4.3 Search .....	13
4.4 Inquiry and manual settings .....	14
4.5 Camera position setting .....	15
4.6 Track recording setting .....	15
5. PTZ camera controller connection .....	17
6. RS-232 connection diagram .....	17
7. RS-485 connection diagram .....	18
8. RS-422 connection diagram .....	18
9. PTZ camera remote control .....	19
10. Accessories .....	19

# 1. Brief Introduction

## 1.1 Overview

PKC3000 is a professional PTZ camera controller that supports RS-422 / RS-485 / RS-232 / IP control, connects up to 255 cameras, provides the ability to control aperture, focus, white balance, exposure, and real-time speed control, and provides more refined camera settings in controlling PTZ cameras, widely used in education, conference, remote medical, medical services and many other industry sectors.



## 1.2 Main Features

- Cross protocol mix-control with IP/ RS-422/ RS-485/ RS-232
- Control protocol by VISCA, VISCA-Over-IP, Onvif and Pelco P&D
- Control up to total of 255 IP cameras on a single network
- 6 camera quick call up keys, and 6 user-assignable keys to quickly invoke shortcut functions
- Quick control of exposure, shutter speed, iris, white balance, focus, pan/tilt speed, zoom speed
- Tactile feel with professional rocker/seesaw switch for zoom control
- Automatically search available IP cameras in a network and assign IP addresses easily
- Multi-color key illumination indicator directs operation to specific functions
- Tally GPIO output for indicating the camera be currently controlled
- Metal housing with 2.2 inch LCD display, 4D joystick, 5 rotation button
- Supports both POE and 12V DC power supplies

## 2.Interfaces

### 2.1 Interfaces



1	Power Switch
2	DC 12V Power
3	TALLY GPIO
4	RS232 (PELCO-D,PELCO-P,VISCA)
5	RS-422/485 (PELCO-D,PELCO-P,VISCA)
6	IP (ONVIF,VISCA Over IP)

### 2.2 Interface definition

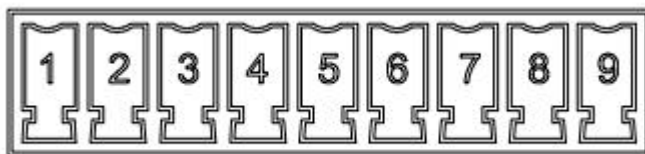

TALLY

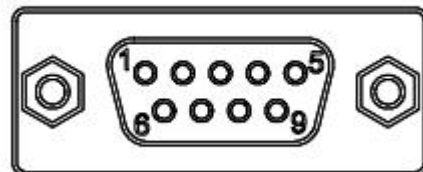

RS-232

TALLY	Function	RS-232	Function
1	Camera1	1	n/c
2	Camera2	2	RX
3	Camera3	3	TX
4	Camera4	4	n/c
5	Camera5	5	GND
6	Camera6	6	n/c
7	Camera7	7	n/c
8	GND	8	n/c
9	GND	9	n/c

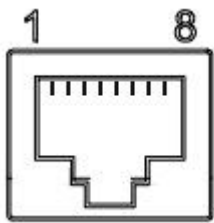

RS-422/485

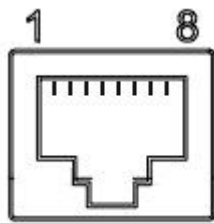

IP

RS-422/485	Function	IP	Function	Color
1(RS-485)	TX+	1	TX+	Orange/White
2(RS-485)	TX-	2	TX-	Orange
3	RX+	3	RX+	Green/White
4	n/c	4	n/c	Blue
5	n/c	5	n/c	Blue/White
6	RX-	6	RX-	Green
7	n/c	7	n/c	Brown/White
8	n/c	8	n/c	Brown

### 2.3 Specification

<b>CONNECTIONS</b>	Interfaces	IP(RJ45)、RS-232、RS-485/RS-422
	Control Protocol	IP Protocol: ONVIF, VISCA Over IP Serial Protocol: PELCO-D, PELCO-P, VISCA
	Serial Baud Rate	2400, 4800, 9600, 19200, 38400 bps

<b>USER INTERFACES</b>	Display	2.2 inch LCD
	Joystick	4D joystick (Pan/Tilt/Zoom/Lock)
	Camera shortcut	6 channel
	Keyboard	User-assignable keys×6, Rotation button×5, Rocker×1, Seesaw×1
	Camera Address	Up to 255
	Preset	Up to 255 Note: 95 preset bit part of the camera for menu call out
<b>POWER</b>	Power	PoE/ DC 12V
	Power Consumption	PoE: 5W, DC: 5W
<b>ENVIRONMENT</b>	Working Temperature	-20°C~60°C
	Storage Temperature	-40°C~80°C
<b>DIMENSION</b>	Dimension(LWD)	270mm(L)×145mm(W)×29.5mm(H)
	Weight	1181g

### 3.Control Panel

#### 3.1 Description



1	Camera Quick Access Control (Aperture/exposure/white balance/focus function settings)
2	6 Camera Call Up& User-assignable keys (Default 6-camera quick connect)
3	Seesaw button (Zoom control)
4	Menu knob (Use for pan/tilt speed, zoom speed control and PTZ camera menu settings) Non-menu status knob to adjust the head rate
5	Camera address and position setting
6	Multi-function digital panel (Inputting numbers, letters, etc.)
7	PTZ joystick (Controlling camera motion action)
8	2.2 inch LCD display



### 3.2 Keyboard Button

#### ■ Camera Quick Access Control

Press the AUTO EXPOSURE button to turn on automatic exposure. In non-auto exposure mode, turn the IRIS knob to manually adjust the camera aperture value, and the status is displayed at the bottom right of the screen.

Press the AUTO WB button to turn on automatic white balance. Press the ONE PUSH WB button, the camera enters the one-touch white balance mode.

Turn the R knob to manually adjust the camera red gain and turn the B knob to manually adjust the camera blue gain, and the status is displayed at the bottom right of the screen.

Press the AUTO AF button to turn on the camera autofocus, and press the ONE PUSH AF button to put the camera into one-touch focus mode.

You can manually adjust the camera focus, and the status is displayed at the bottom right of the screen.



#### ■ 6 Camera Call Up & User-assignable keys

Press the shortcut keys F1-F6 to quickly call the corresponding camera, you can also customize the key function according to user requirements, the specific function is set inside the menu.



#### ■ Seesaw button

Press the seesaw T button to pull the camera focus farther, and press the seesaw W button to pull the camera focus closer, in addition, you can also use the PTZ joystick to control the camera zoom, and the status is displayed at the bottom right of the screen.

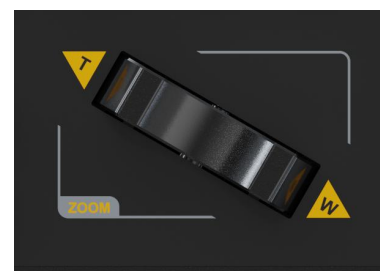

#### ■ Menu knob

Press the SETUP button to enter the controller menu. The menu options can be selected by the knob. In non-menu mode, the rotary knob is used to control the PTZ head rate and is displayed in the lower right of the screen. Press to adjust the rate of PT and Z.

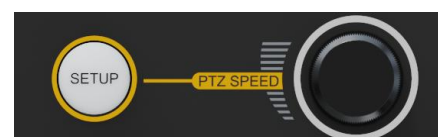

■ Multi-function digital panel

The numeric panel allows you to enter numbers, letters, etc. The following keys are multiple use buttons

"<" (HOME key): Short press to delete the previous character, long press the key to return to the starting position.

"0 key" (BLC key): Short press to enter the number 0, long press the key to turn on the Backlight compensation

"←" (MENU key): Short press to confirm, long press the key to call up the camera's menu. When entering letters, short press to switch case.



■ Camera address and position setting

**SEARCH:** Controller's camera search

**INQUIRY:** Controller's camera inquiry, 255 CAM queries, parameter modifications, or manual camera additions.

**CAM:** Recall the specified camera, press the number of the specified camera on the panel, and then press the button to switch the camera.

**PRESET:** Camera set preset position, input the number on the panel, then press the PRESET button to store the camera position.

**RESET:** The camera clears the preset position, input the number on the panel, and then press RESET to clear the camera preset position

**CALL:** Recall the preset position, input the number on the panel, then press CALL button, then the camera recalls the specified preset position.

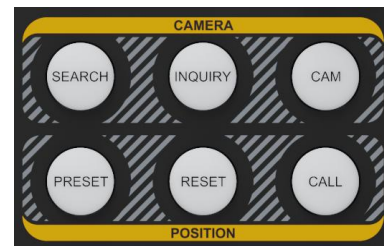

■ Screen

Display of menu settings, display of status page.

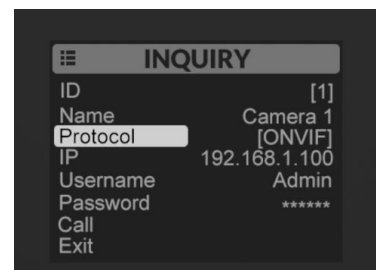

■ **PTZ joystick**

Used to control camera motion .

Used for menu control when calling up the camera menu:

Move the PTZ joystick up and down to select menu options

Move the PTZ joystick left and right to adjust and modify menu values (Suitable for PTZ1270 series)

Rotate the PTZ joystick left and right to call out the upper and lower sub-menus, left to return to the previous level menu, right to enter the next level menu. (Suitable to PTZ1270 series)

The button on the PTZ joystick is the Locked button, which locks the operation.



## 4.Menu Settings

### 4.1 STATUS

The status page displays the camera address, camera name, control protocol and protocol related information (IP Address, baud rate, UDP port and other information). Under the status page, turn the knob to control the PTZ camera speed.The status page as following:

STATUS		STATUS	
[0]	Camera 0	[0]	Camera 0
Protocol	VISCA-IP	Protocol	VISCA-IP
IP	0.0.0.0	IP	0.0.0.0
UDP Port	52381	UDP Port	52381
			PTZ Speed [100%]

In addition, the information of the number entered will be displayed in the lower left corner of the status page, and the information of the operation will be displayed in the lower right corner.

For example, if you enter the number 10, the number 10 will be displayed in the lower left corner, and when you press CALL button, the information of that operation will be displayed in the lower right corner, as shown in the figure.

STATUS		STATUS	
[0]	Camera 0	[0]	Camera 0
Protocol	VISCA-IP	Protocol	VISCA-IP
IP	0.0.0.0	IP	0.0.0.0
UDP Port	52381	UDP Port	52381
[10]			Call Position [10]

## 4.2 SETUP

Press SETUP on the button panel to enter the SETUP menu.

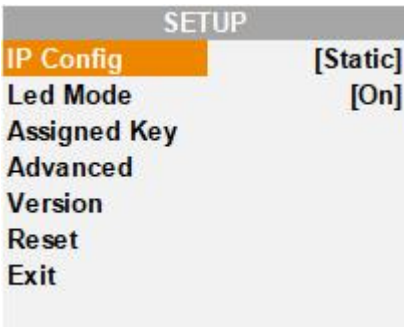

### 4.2.1 IP Config

Select the IP Config option and press the menu knob to configure the IP of the controller.

#### ● Network

There are two ways to acquire the IP: Dynamic (IP configured by router) and Static (set IP freely by yourself). Select the method you need by knob menu. The default setting is Static, and the default IP address is 192.168.5.177.

Dynamic: Connecting the PTZ camera with a router with DHCP features, then it will auto obtain an IP address automatically. Make sure that PTZ camera and PTZ controller are in the same local area network.

Static: Select static IP acquire method when the PTZ camera is without DHCP. Connect the PTZ camera controller and PTZ camera through the network cable, and set the IP address of PTZ camera and PTZ camera controller in the same network segment.

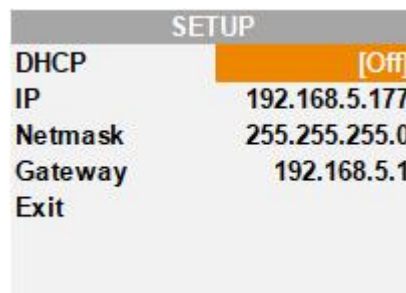
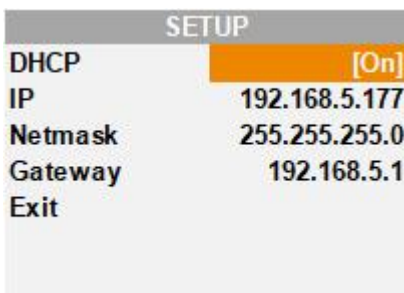

#### ● Netmask

Set the NetMask. The default setting is 255.255.255.0.

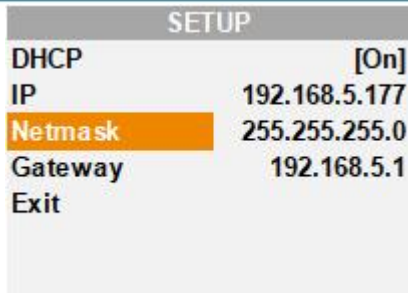

● **Gateway**

Set the GateWay according to current IP address. The default setting is 192.168.5.1.

When the network setup is complete, exit the menu to save the configuration automatically.

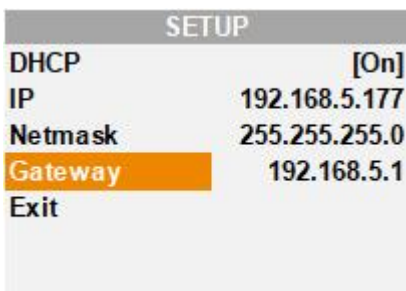

**4.2.2 LED setting**

Turn on the LED mode, the key light on the panel is always on, turn off the LED mode, the key light on the panel is off.

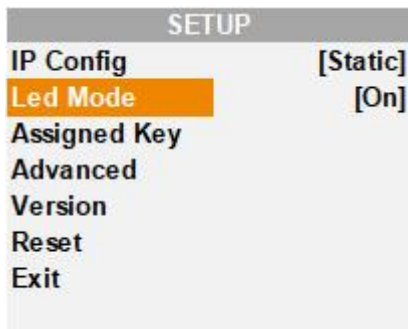

**4.2.3 Assigned key**

Assigned keys can be configured as shortcuts to activate camera functions. Long press the F button to quickly execute the corresponding function of the configuration, short press to quickly connect the corresponding camera.

From the keyboard settings menu, move the cursor to the specified "Key" field, select the shortcut key to be configured and click on the rotary speed knob to apply the function to the shortcut key.

F1, F2, F3, F4, F5 and F6 can be configured as shortcuts, with functions such as flipping the camera image up and down and left and right, and freezing the camera screen, etc. And the CMD1-6 supports six

user-defined Camera control command.

Enter the CMD settings, users can enter the Camera control command according to the actual needs, to achieve the quick execution of functions that are not available on the panel, it supports the input of commands from 0-F, and the length of the input command is no more than 12 characters (6 HEX).

**Note:** Only ports 52381 and 1259 are sent for custom command network control, camera function commands can be obtained from the camera manual or from the manufacturer.

SETUP		SETUP	
F1	[CMD 5]	CMD1	8101040B02FF
F2	[Cam 2]	CMD2	8101040B03FF
F3	[Cam 3]	CMD3	8101060605FF
F4	[Flip]	CMD4	8101060604FF
F5	[Freeze]	CMD5	
F6	[Mute]	CMD6	
CMD Setting			
Exit		Exit	

Assigned key can be assigned to camera features from following:

1	Cam N	Quick call camera N
2	Home	Returning the camera to the start position
3	P/T Reset	Reset the selected camera
4	Power	Power off the selected camera
5	Mute	Mute the audio from the selected camera
6	Freeze	Freeze the image of the selected camera
7	Flip	Flip the image of the selected camera (Flip Up and down)
8	LR Reverse	Invert the L/R (pan direction) of the selected camera (Flip left and right)
9	CMD1-6	Customised camera control command settings

### 4.2.4 Advanced

Entering Advanced settings from the menu to setting the Track loop ,Quick call,and theme.

SETUP		SETUP	
IP Config	[Static]	Track Loop	[On]
Led Mode	[On]	Quick Call	[Off]
Assigned Key		Theme	[color 1]
Advanced		Exit	
Version			
Reset			
Exit			

● **Track Loop**

When the Track loop is on, the camera will play back the recorded track.

When the Track loop is off, the camera will only play back the looped track once.

The track recording procedure is described in (4.6)

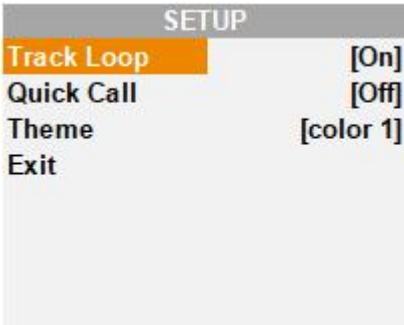

● **Quick Call**

Quickly call camera preset positions.

When you turn on “Quick Call”, you can directly and quickly recall to the preset positions by simply pressing the keypad number.

If you turn off “Quick Call”, pressing the preset number will not recall to the preset positions, you need to select the preset number and then press “CALL” or enter key to reach the recall preset bit.

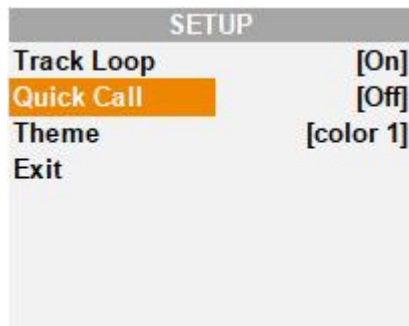

● **Theme**

Entering SETUP settings from the menu to switch the screen skin style. There are four styles to choose from Color1/Color2/Color3/Color4.

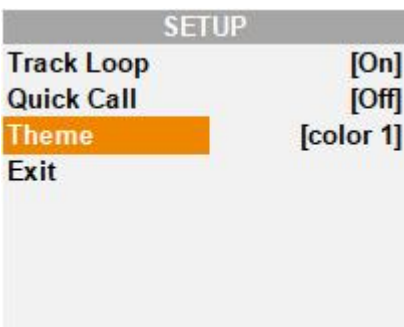

### 4.2.5 Version

Enter the menu to check the APP version and MCU version of the PTZ camera controller.

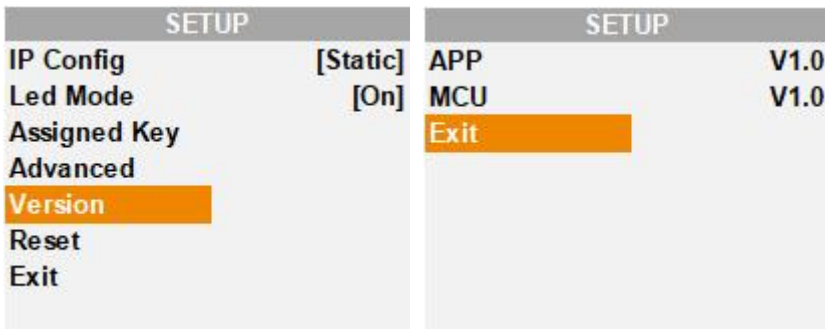

### 4.2.6 Reset

Clear all keyboard settings, and restore factory default.

NOTE: Don't move the Joystick nor the Zooming Seesaw and leave them at original position while the FACTORY DEFAULT is processing.

Select Exit and press the menu knob to exit this menu page and return to the status page.



### 4.3 Search

The controller supports both VISCA-IP and ONVIF protocols to search cameras, you need to configure the network first. Confirm that the camera and the controller in the same LAN segment, such as the camera IP 192.168.5.163, the controller IP 192.168.5.177, only in the same network segment to achieve the search function, press the SEARCH button on the panel and select VISCA-IP, ONVIF protocol through the menu. Select the protocol according to the situation and start the search.

When the search is complete, all cameras searched will be displayed, click on the corresponding IP to enter the camera corresponding camera settings, and then click "Save" to save.





If the search result shows none, it means that the camera is not found.



Note: The auto search function only searches the default port number of the protocol, VISCA-IP control port is 52381, if the camera control port number is not the default port may not be automatically searched, you need to manually modify the addition through the INQUIRY key.

### 4.4 Inquiry and manual settings

The controller stores a total of 255 cameras (1~255). By pressing the INQUIRY button on the status page, you can query the information of any camera on the INQUIRY query page, or enter a number and click the "INQUIRY" button to query the information of the camera with the corresponding number address.

In addition, the INQUIRY page allows you to easily change the camera's configuration, including: camera name, camera protocol, camera IP, baud rate, UDP port, user name, password, etc. The PELCO-D, PELCO-P and VISCA protocols have a baud rate configuration and port selection configuration, the ONVIF and VISCA-IP protocols have an IP configuration, and ONVIF requires both a user name and password configuration (need to match the camera).

The user name and password used in the ONVIF protocol can be changed. Press once on the number panel and enter the corresponding number, press twice or more times in a row to enter the corresponding letter. Press once on the panel to input the number and twice or more times to input the letter. Press the Enter key to switch the letter case.

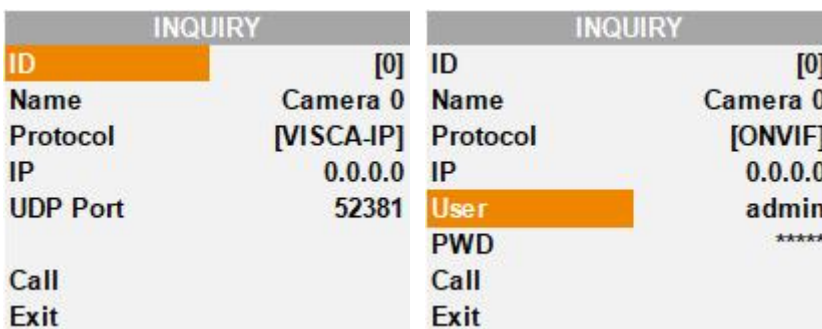

When the camera cannot be searched or the connection information of the camera needs to be added manually, it can be achieved by INQUIRY key. First, select the serial number of the camera that needs to be modified or added, the status page will show that the connection timeout is ignored, and then press INQUIRY key to modify the connection information to achieve the operation of adding the camera manually.

## 4.5 Camera position setting

- **Setting / creating presets:**

Move the camera to the desired position, Enter the desired preset number on the alphanumeric keyboard, such as "77" and then press the Preset button to save the preset.

STATUS		STATUS	
[0]	Camera 0	[0]	Camera 0
Protocol	VISCA-IP	Protocol	VISCA-IP
IP	0.0.0.0	IP	0.0.0.0
UDP Port	52381	UDP Port	52381
[77]			Set Position [77]

- **Calling presets:**

Enter the desired preset number on the alphanumeric keyboard such as "77", short press the Call button or the Enter key. When "Quick call" is turn on, press the numeric keys 0-9 to call the 10 preset positions directly.

STATUS		STATUS	
[0]	Camera 0	[0]	Camera 0
Protocol	VISCA-IP	Protocol	VISCA-IP
IP	0.0.0.0	IP	0.0.0.0
UDP Port	52381	UDP Port	52381
[77]			Call Position [77]

- **Resetting / Clearing presets:**

Enter the number of the preset you would like to clear such as "77", and then Press the Reset button.

STATUS		STATUS	
[0]	Camera 0	[0]	Camera 0
Protocol	VISCA-IP	Protocol	VISCA-IP
IP	0.0.0.0	IP	0.0.0.0
UDP Port	52381	UDP Port	52381
[77]			Track deleted [77]

Note: The Quick Call function needs to be off when setting and clearing preset positions.

## 4.6 Track recording setting

- **Setting a track recording:**

On the alphanumeric keyboard, enter the preset number of the desired track, such as "11", and then long press the "PRESET" button to start recording the camera track, after recording, press the "PRESET" button to Save the preset and finish recording.

STATUS		STATUS		STATUS	
[0]	Camera 0	[0]	Camera 0	[0]	Camera 0
Protocol	VISCA-IP	Protocol	VISCA-IP	Protocol	VISCA-IP
IP	0.0.0.0	IP	0.0.0.0	IP	0.0.0.0
UDP Port	52381	UDP Port	52381	UDP Port	52381
[11]	Going to preset		Track recording...		Recording complete

- **Playback track recording:**

Enter the preset number of the track on the alphanumeric keyboard, such as "11", and then long press the "CALL" button to playback the camera track number "11". You can set the track loop from the menu. If you turn on the track loop, the camera will repeat the recorded track, if you turn off the record loop, the camera will only play back the looped track once.

STATUS		STATUS		STATUS	
[0]	Camera 0	[0]	Camera 0	[0]	Camera 0
Protocol	VISCA-IP	Protocol	VISCA-IP	Protocol	VISCA-IP
IP	0.0.0.0	IP	0.0.0.0	IP	0.0.0.0
UDP Port	52381	UDP Port	52381	UDP Port	52381
[11]			Track playback...	[11]	Stop playback

During the playback of the recorded track, moving the joystick or pressing the seesaw button will immediately stop the playback of the recorded track. Locking the operation via the lock button on the joystick prevents the track playback interrupted by misuse.

- **Reset/clear track recording:**

Enter the track number "11" and press and hold the "RESET" button to reset/clear the track recording.

STATUS		STATUS	
[0]	Camera 0	[0]	Camera 0
Protocol	VISCA-IP	Protocol	VISCA-IP
IP	0.0.0.0	IP	0.0.0.0
UDP Port	52381	UDP Port	52381
[11]		[11]	Track deleted

### 5. PTZ camera controller connection

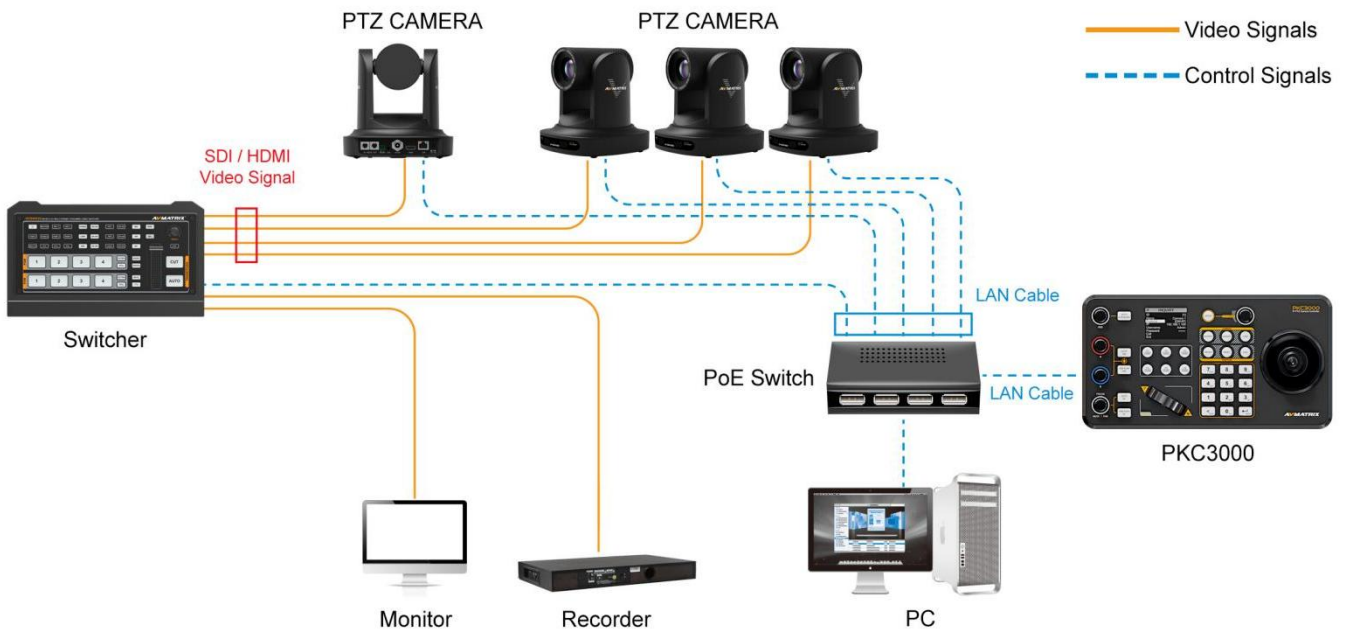

### 6. RS-232 connection diagram

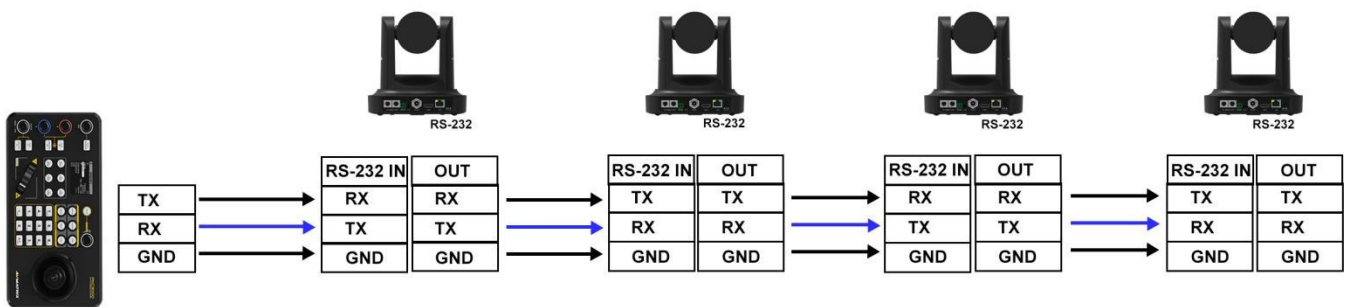

### 7. RS-485 connection diagram

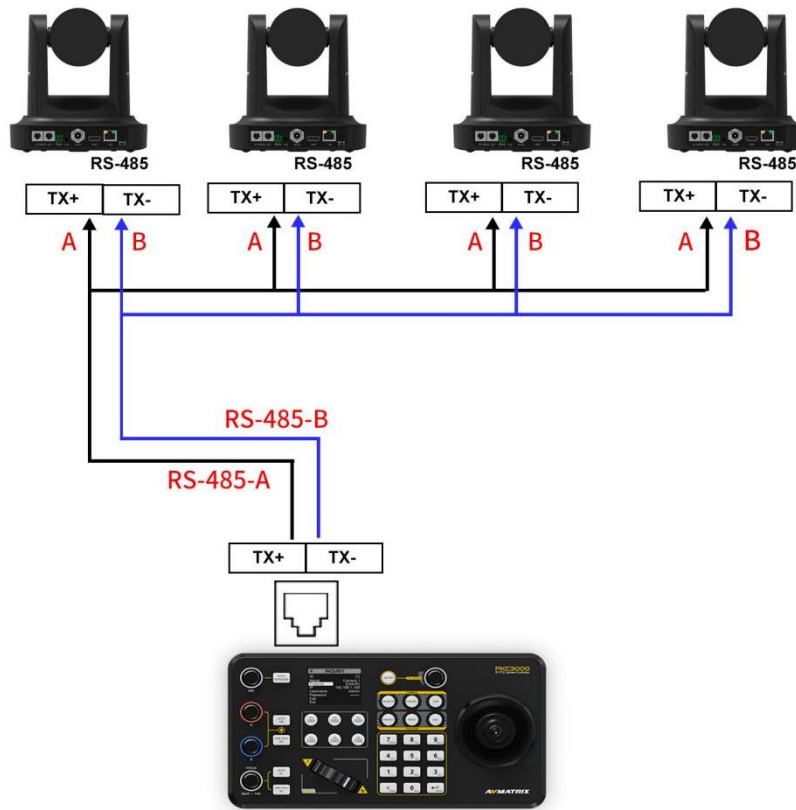

### 8. RS-422 connection diagram

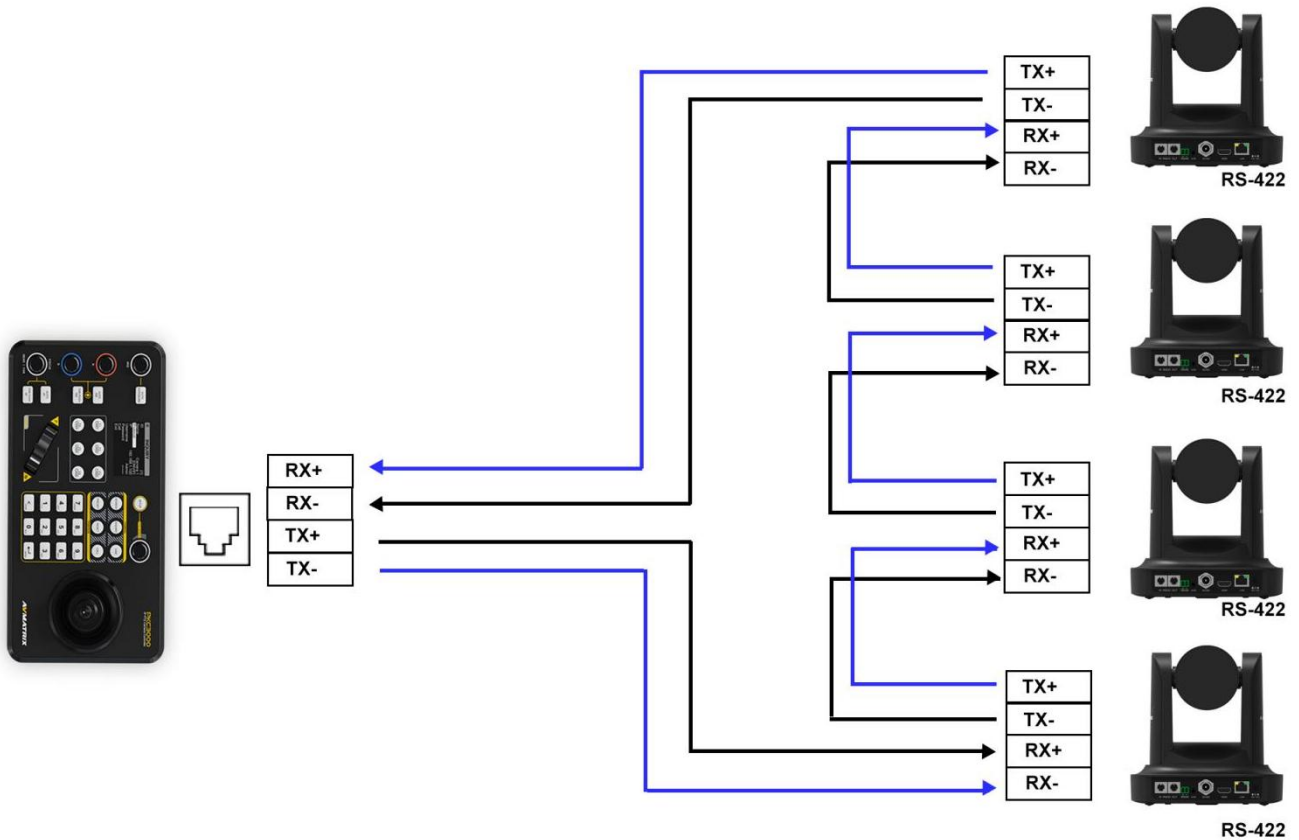

## 9. PTZ camera remote control



Wireless remote control of the PTZ camera can be achieved with the TS3019's serial pass-through function.

## 10. Accessories

This PTZ camera controller is equipped with a 12V power adapter and a 9 PIN GPIO connector.

